

AntoviaTM
decor

**VOGUSH
COLLECTION**

**GLORIOUS DECOR THAT
CREATES A STRIKING
FIRST IMPRESSION**

**SOFFIT CEILING
& WALL SYSTEMS**

www.antoviadecor.com

SOFFIT CEILING & WALL SYSTEMS

Antovia™
decor



REAL WOOD
FEEL



WATERPROOF



STAIN FREE



ANTI-
BACTERIAL



MAINTENANCE
FREE



EASY TO
CLEAN



NO VOC
EMISSION



SEAMLESS
POST
INSTALLATION



TERMITE
PROOF & RUST
PROOF



LIGHT WEIGHT

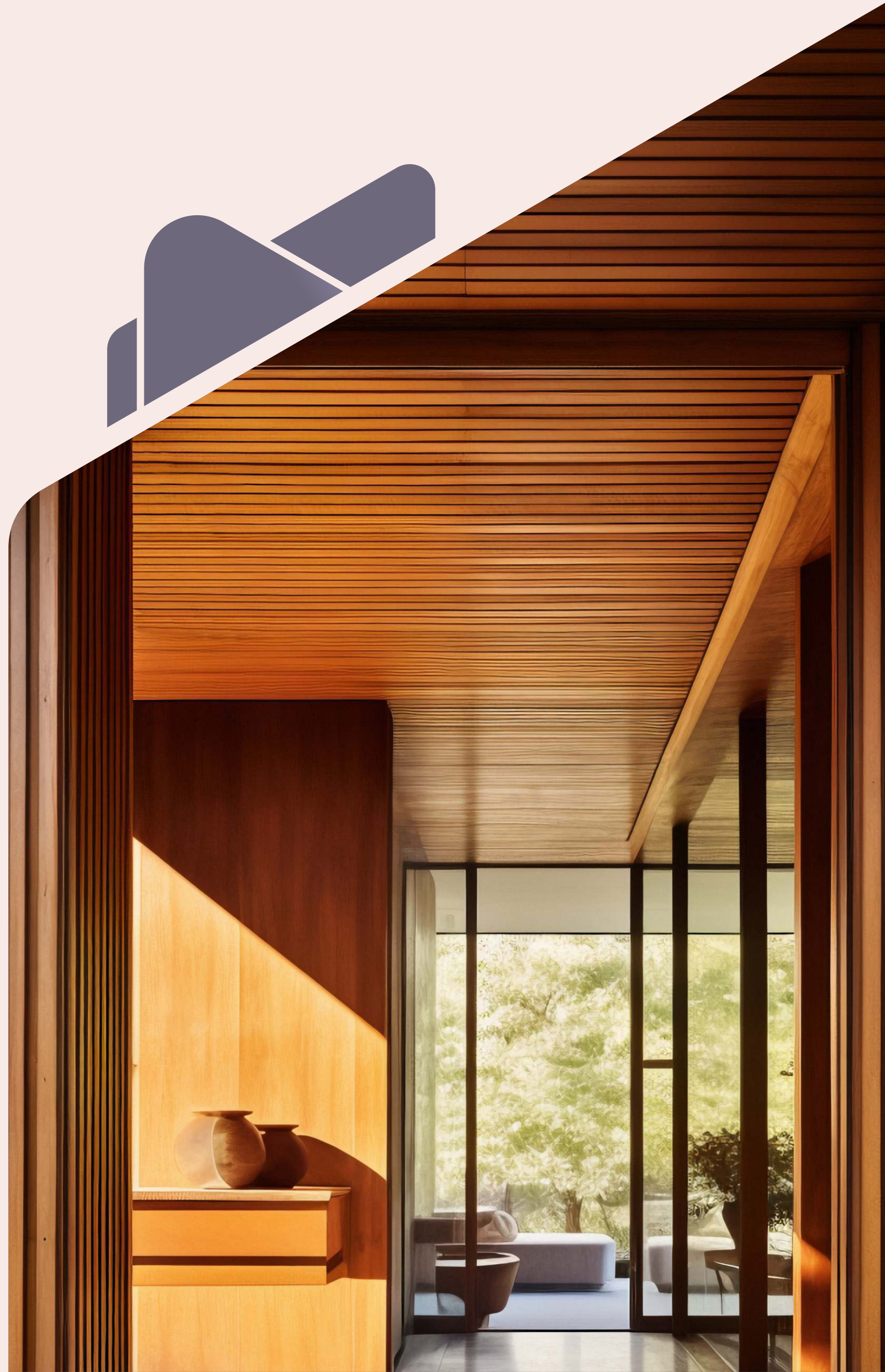



**UNBREAKABLE,
ULTRALIGHT,
ULTRACHIC
SOFFIT PANELS !**

SOFFIT CEILING & WALL SYSTEMS

AntoviaTM
decor



VC-001



SOFFIT CEILING & WALL SYSTEMS

Antovia™
decor



VC-002



SOFFIT CEILING & WALL SYSTEMS

Antovia™
decor



VC-003



SOFFIT CEILING & WALL SYSTEMS

AntoviaTM
decor



VC-004



SOFFIT CEILING & WALL SYSTEMS

Antovia™
decor



VC-005

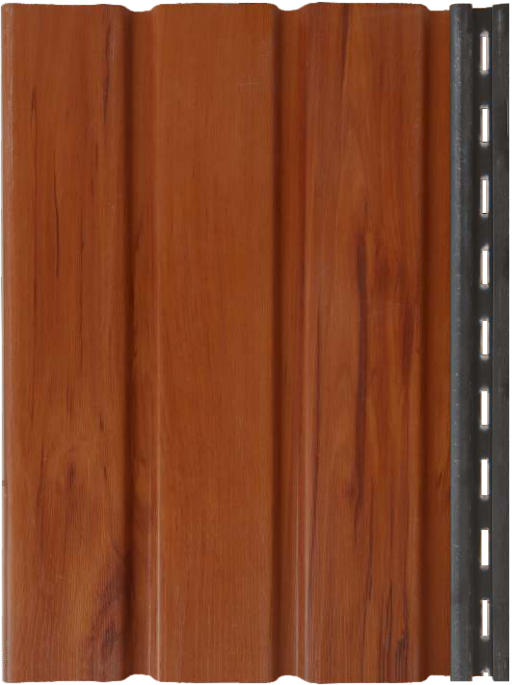

SOFFIT CEILING & WALL SYSTEMS

AntoviaTM
decor



VC-006



SOFFIT CEILING & WALL SYSTEMS

Antovia™
decor

VC-007



SOFFIT CEILING & WALL SYSTEMS

Antovia™
decor



VC-008



SOFFIT CEILING & WALL SYSTEMS

Antovia™
decor



VC-009

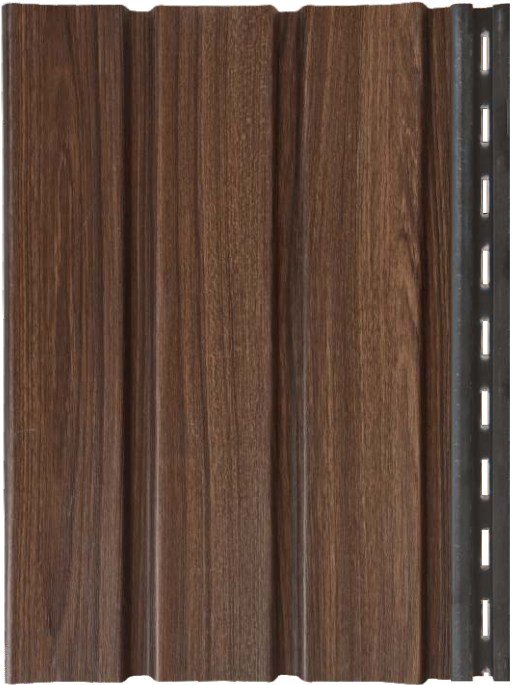

SOFFIT CEILING & WALL SYSTEMS

AntoviaTM
decor



VC-010



SOFFIT CEILING & WALL SYSTEMS

Antovia™
decor



VC-011

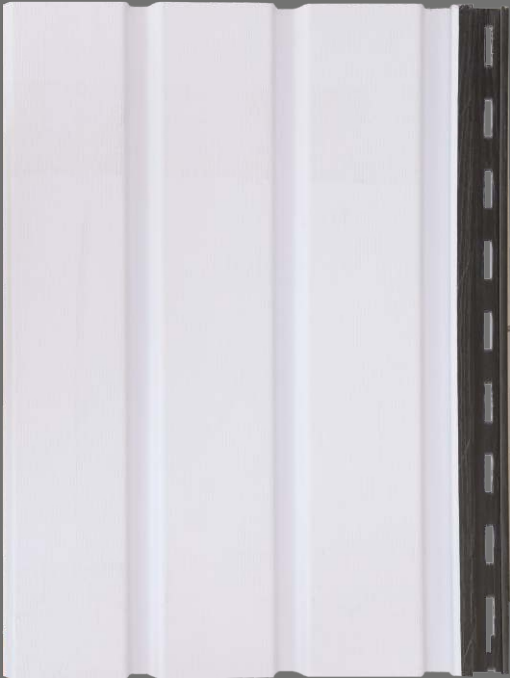

SOFFIT CEILING & WALL SYSTEMS

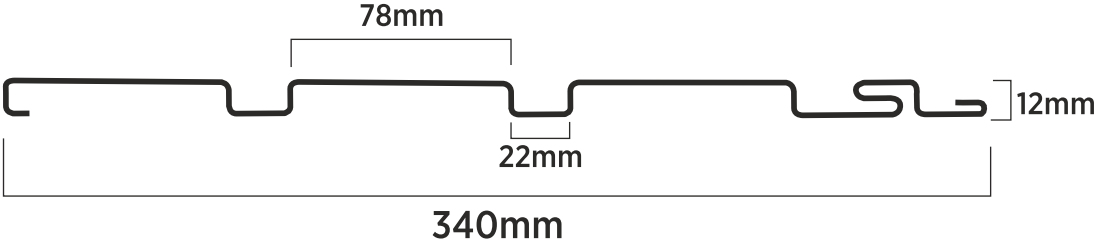

J-Trim

Perimeter profile

Accessory 1



**Outside
Corner Profile**

Accessory 3

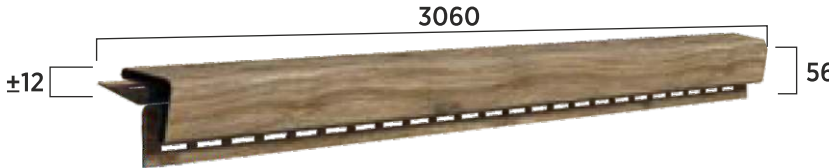

T-Trim

Connector Profile

Accessory 2

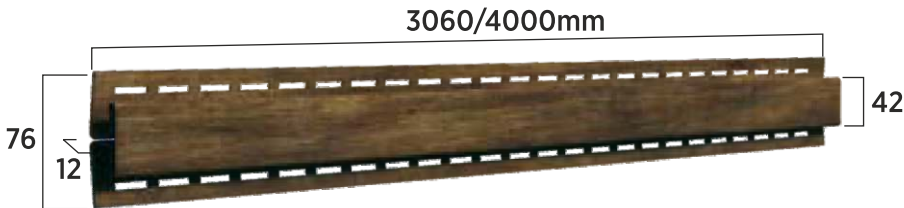

**Inside
Corner Profile**

Accessory 4

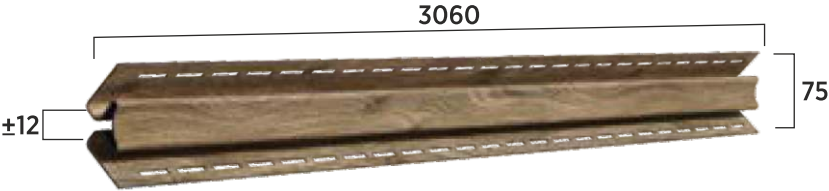

SOFFIT CEILING & WALL SYSTEMS

AntoviaTM
decor

1.

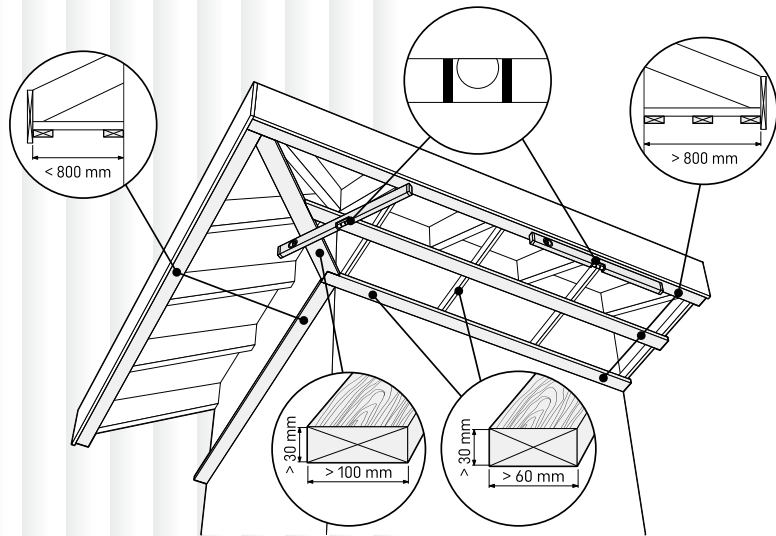

2.

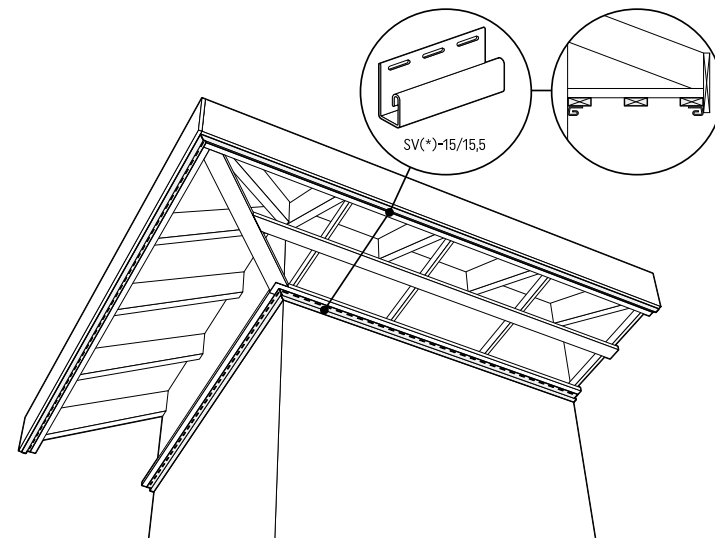

3.

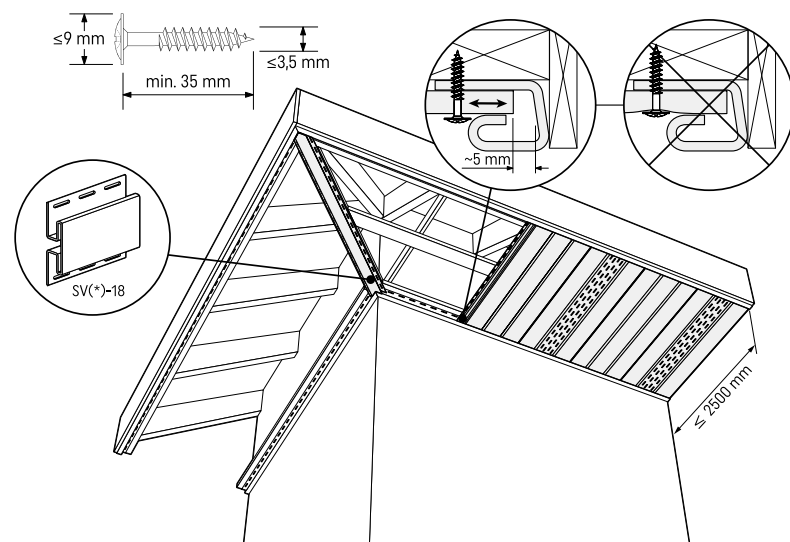

4.

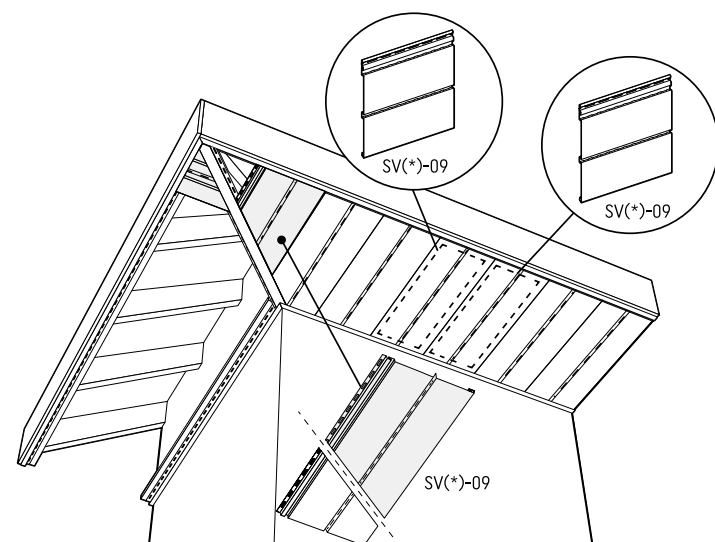

5.

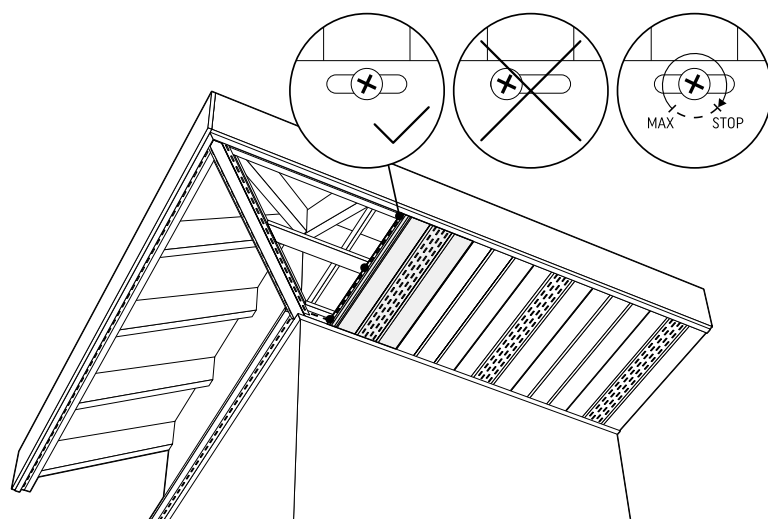

6.

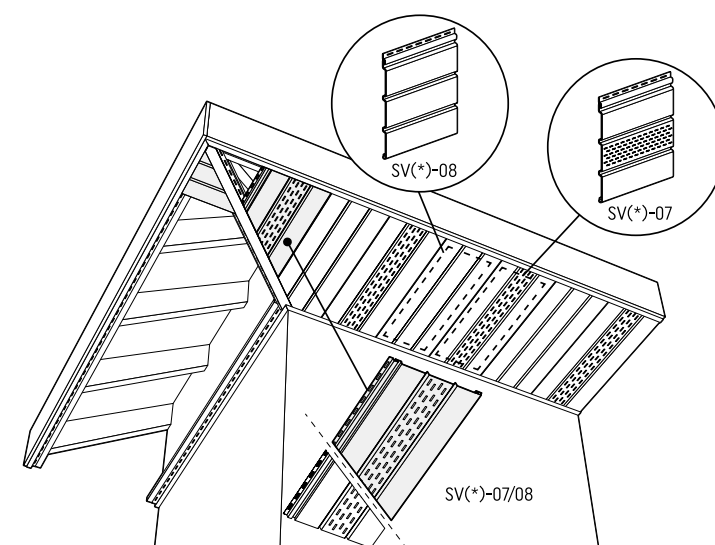



Antovia[™]
decor

8-A, National Highway, At. Timbadi,
Morbi 363 642, Gujarat, India.

Email id : info@antoviadecor.com

Website : www.antoviadecor.com